

Multiprotocol Set in IP67 TI-BL67-EN-6

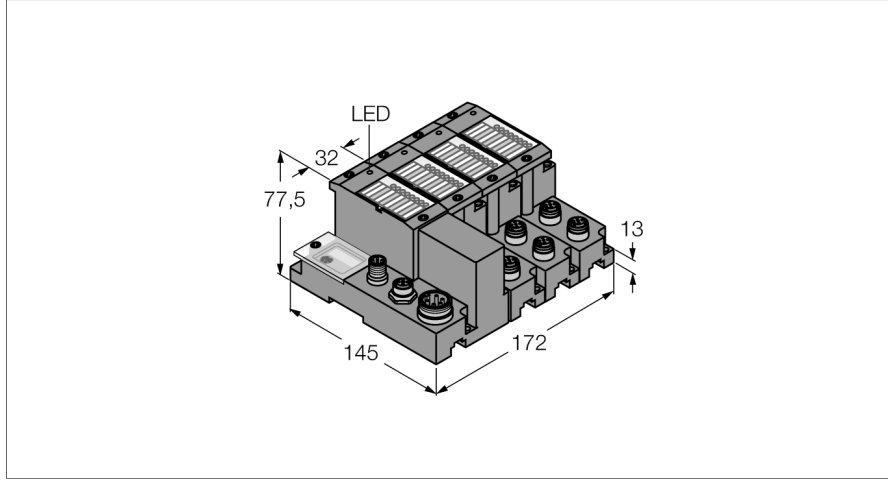

- Connection of up to 6 read/write heads via BL ident M12 extension cables
- Mixed operation of HF and UHF read/write heads

Güç Kaynağı

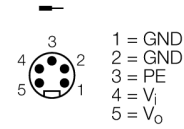

Kablo Bağlantı Şeması

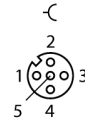

Tip kodu	TI-BL67-EN-6
İdent no.	7030612
Kanal sayısı	6
Boyutlar (W x L x H)	172 x 145 x 77.5 mm
Besleme gerilimi	24 VDC
max. system supply current $I_{mb(SV)}$	1.3, A
Max. sensor supply I_{sens}	4 A electronically limited current supply electronically limited current supply
max. load current I_o	10 A
Kabul edilebilir aralık	18...30 VDC
Servis arayüzü	Mini USB, Ethernet
Gerilim besleme bağlantısı	7/8", 5 pimli
Transmission rate	115,2 kb/sn
Elektrik yalıtımı	isolation of electronics and field level via opto-couplers
Çıkış bağlantısı	M12
Sensör besleme	0.5 A per channel, short-circuit proof
Sıcaklık değer kaybı	
> 55 °C Circulating air (Ventilation)	no limitation
> 55°C Sabit ortam havası	$I_{sens} < 3A, I_{mb} < 1A$
Bağıl nem	%5...95 (dahili), seviye RH-2, yoğunlaşmaz (45°C'de depolandığında)
Titreşim testi	EN 61131 uyarınca
Genişletilmiş titreşim direnci	VN 02-00 and higher
- up to 5 g (at 10 to 150 Hz)	for mounting on DIN rail no drilling according to EN 60715, with end bracket
- up to 20 g (at 10 up to 150 Hz)	for mounting on base plate or machinery Therefore every second module has to be mounted with two screws each.
Darbe testi	IEC 60068-2-27 uyarınca
Düşme ve devrilme	acc. to IEC 68-2-31 and free fall to IEC 68-2-32
Elektromanyetik uyumluluk	EN 61131-2 uyarınca
IP Derecesi	IP67
teslimata dahildir	1 x uç plaka, BL67

İşlevsel prensip

BL67 ağ geçitleri, bir BL67 santralinin ana bileşenleridir. Modüler fieldbus nodlarını daha yüksek seviye fieldbus'a (PROFIBUS-DP, DeviceNet, CANopen, Ethernet, Modbus TCP, PROFINET, EtherCAT veya EtherNet/IP) bağlamak üzere tasarlanmıştır.

Tüm BL67 elektronik modülleri, verileri ağ geçidi ile fieldbus'a aktarılan dahili modül veri yolu üzerinden iletişim kurar. Bu nedenle tüm G/Ç modülleri veri yolu sisteminden bağımsız olarak yapılandırılabilir.

The pin resp. signal assignment results from the combination with an electronic module. You find the pin configuration and the wiring diagrams on the data sheet of the corresponding electronic module.

BL67 base modules are connected to the right of the gateway, using two screws for each module. A DIN rail is not required. This way, a compact and stable unit is built. The unit can now be mounted on a DIN rail or directly on the machine.

The field devices are connected to the base modules which are available with different connection technology (M8, M12, M23 and 7/8").

Note

Further technical data like temperature range are determined by the electronic modules and can be found on the data sheets.

Multiprotocol Set in IP67 TI-BL67-EN-6

BL67 electronic modules are plugged on the purely passive base modules which in turn are connected to the field devices. The separation of connection level and electronics simplifies maintenance considerably. Flexibility is enhanced because the user can choose between base modules with different connection technologies.

The electronic modules are completely independent of the higher level fieldbus through the use of gateways.

BL67 ađ geitleri, bir BL67 santralinin ana bileşenleridir. Modüler fieldbus nodlarını daha yüksek seviye fieldbus'a (PROFIBUS-DP, DeviceNet, CANopen, Ethernet, Modbus TCP, PROFINET, EtherCAT veya EtherNet/IP) bağlamak üzere tasarlanmıştır.

Tüm BL67 elektronik modülleri, verileri ađ geidi ile fieldbus'a aktarılan dahili modül veri yolu üzerinden iletişim kurar. Bu nedenle tüm G/Ç modülleri veri yolu sisteminden bağımsız olarak yapılandırılabilir.

Multiprotocol Set in IP67 TI-BL67-EN-6

Pim ataması ve tedarik kavramı

	<p>Ethernet Ports Starting from version VN 03-00, the gateway features two D-coded M12 Ethernet ports with integrated switch. The ports are used as interfaces for configuration and fieldbus communication. The gateway supports the EtherNet/IP™ and Modbus TCP protocols</p>	<p>Tel ataması</p> <p>1 = YE (TX +) 2 = WH (RX +) 3 = OG (TX -) 4 = BU (RX -)</p>
	<p>Power Supply Double-tuned power supply of the BL67 system.</p> <p>System power supply V_i V_i is for the internal system supply at the backplane bus ($V_{MB(EV)}$) and for the 4A short-circuit limited sensor supply (V_{sens}).</p> <p>Load voltage V_o V_o for output supply, limited to max. 10A.</p>	<p>Tel ataması</p> <p>1 = GND 2 = GND 3 = PE 4 = V_i 5 = V_o</p>
	<p>Ethernet Ports Portlar, yapılandırma ve fieldbus iletişimi için arayüz olarak kullanılır. Ağ geçidi, EtherCAT'i destekler.</p>	<p>Pim ataması</p> <p>1 = YE (TX +) 2 = WH (RX +) 3 = OG (TX -) 4 = BU (RX -)</p>
	<p>Power Supply BL67 sistemi, iki devreli güç ile beslenir.</p> <p>Sistem beslemesi V_i V_i, arka düzlem veri yolundaki dahili sistem beslemesi ($V_{MB(EV)}$) ve 4 A kısa devre akım sınırlı sensör beslemesi (V_{sens}) içindir.</p> <p>Yük gerilimi V_o V_o çıkışları beslemek içindir ve maks. 10 A ile sınırlıdır.</p>	<p>Pim ataması</p> <p>1 = GND 2 = GND 3 = PE 4 = V_i 5 = V_o</p>

Multiprotocol Set in IP67
TI-BL67-EN-6

Compatible base modules

Ölçekli çizim

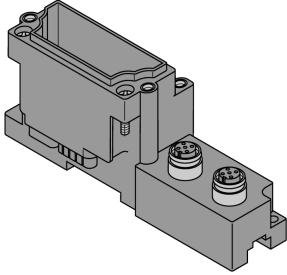

Type

BL67-B-2M12
6827186
2 x M12, 5-pole, female, a-coded

Pin configuration

Konektörler .../S2500

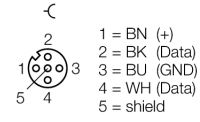

.../S2501 Connectors

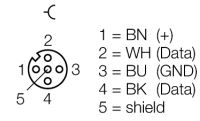

Connectors .../S2503

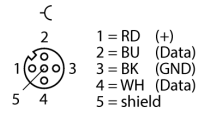

Multiprotocol Set in IP67

TI-BL67-EN-6

LED display

LED	Color	Status	Meaning
D		OFF	No error message or diagnostics active.
	RED	ON	Failure of module bus communication. Check if more than 2 adjacent electronic modules are pulled. Relevant modules are located between gateway and this module.
	RED	FLASHING (0.5 Hz)	Upcoming module diagnostics
RW0 / RW1		OFF	No tag, no active diagnostics
	GREEN	ON	Tag available
	GREEN	FLASHING (2 Hz)	Data exchange with tag enabled
	RED	ON	Read/write head error
	RED	FLASHING (2 Hz)	Short-circuit in the supply line of read/write head