

# Accessories

## Mounting Clamp

### BSS-08

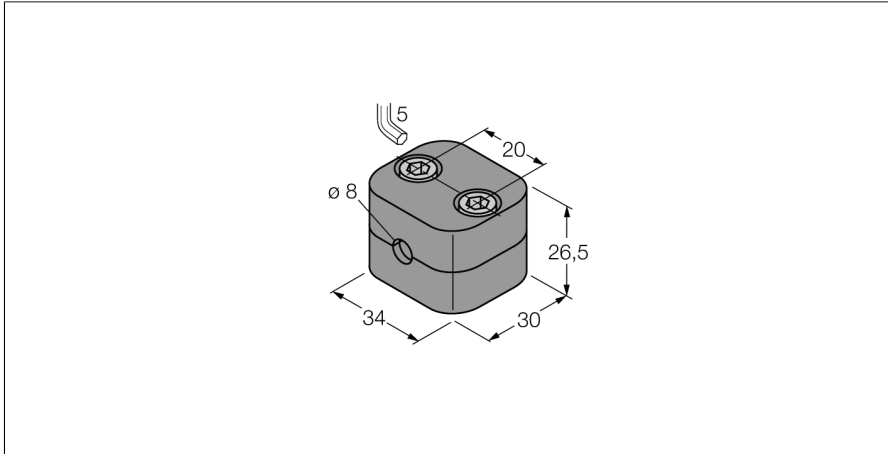

- Mounting clamp for M8 × 1 sensors
- Plastic, polypropylene

#### General description

The portfolio consists of two half-shells and two Allen screws each. Optionally, welding plates or DIN rail nuts can be used (to be ordered separately).

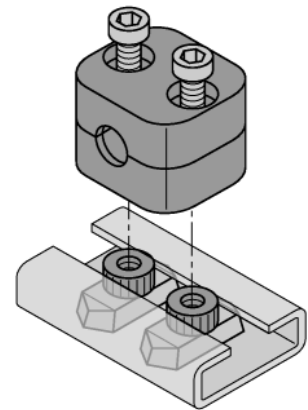
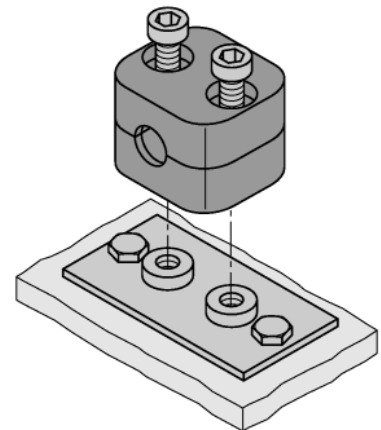

Type	BSS-08
ID	6901322
Design	Accessories for threaded barrel, M8
Dimensions	30 x 34 x 26.5 mm
Housing material	Plastic, PP, Green
Max. tightening torque of housing nut	0.5 Nm
Included in delivery	2 x Allen screws, M6

## Accessories

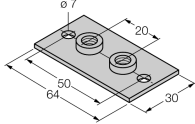
Type code	Ident no.		Dimension drawing
BSS-SPV1	6901317	Weld-on plate for BSS mounting brackets	
BSS-TSM 2 pcs	6901323	DIN rail nut for BSS and BSM mounting clips, for mounting on DIN rails	