

WLB92XB1100PBQ

LED Linear Light – In the Metal Housing

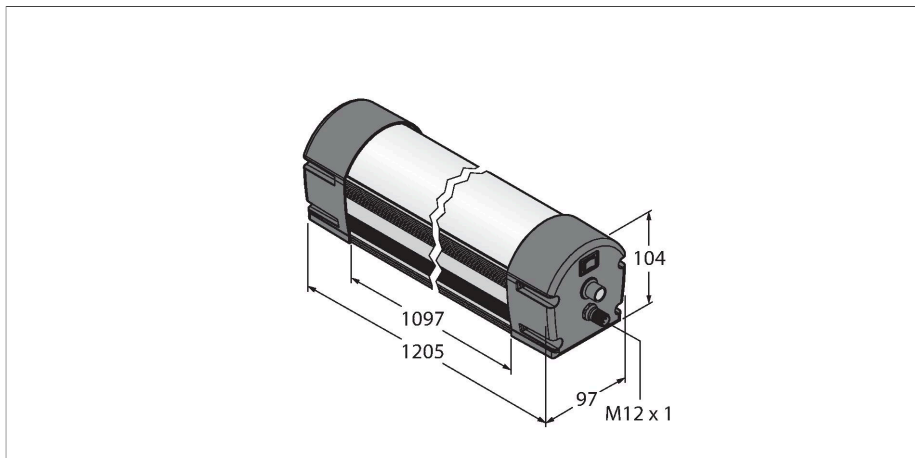

Technical data

Type	WLB92XB1100PBQ
ID	3800890
Signal and display data	
Purpose	LED work light
Function	Linear light
Light type	Blue
Dimmable	Potentiometer
Features of color 1	Blue, Permanently on, 840 lm
Electrical data	
Operating voltage U_b	21.6...26.4 VDC
DC rated operating current I_o	≤ 2900 mA
Mechanical data	
Cascadable	No
Design	Rectangular, WLB92
Dimensions	1226 x 97 x 104 mm
Housing material	Metal, AL, Anodized
Window material	Polycarbonate, diffuse
Electrical connection	Connector, M12 × 1
Number of cores	4
Ambient temperature	-40...+70 °C
Protection class	IP40
Tests/approvals	
Approvals	CE

Features

- Light beam: 1100 mm
- Operating voltage: 24 VDC (±10%)
- Protection class: IP50
- Color: Blue
- M12 x 1 male
- Built-in ON/OFF switch
- Integrated rotary switch for continuous dimming of the light output (0% - 100%)

Wiring diagram

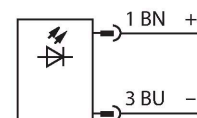

Functional principle

The WLB92 LED linear light is designed for multi-purpose use, is powered by 24 VDC and convinces by its robust metal housing and shatter-proof window material. With the built-in toggle switch, the light can be switched on or off and also fully dimmed, 0%-100%, by the rotary switch. The color temperature lies in the range of daylight, between 5,000 and 10,000 Kelvin. With a lifetime of 50,000 hours and very energy efficient LEDs, this a cost-saving and environmentally friendly alternative to conventional fluorescent lamps. This linear light is available in two lengths and more than twice as bright as the known WLB32 LED light.

Accessories

LMBWLB92

3093567

Snap bracket for WLB92 work light, included in the WLB92 scope of delivery

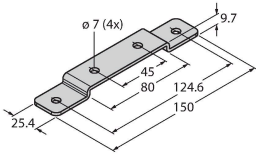

LMBWLB92CLIP

3093568

Snap bracket for WLB92 linear light

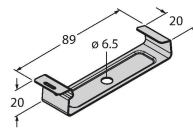

LMBWLB92HK5

3093569

Pendant mounting bracket for WLB92

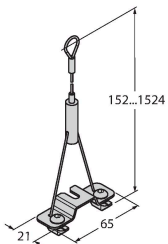

LMBWLB92S

3093570

Mounting bracket for front side mounting of the WLB92

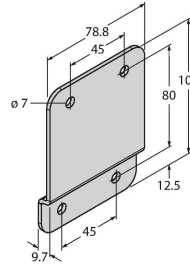

LMBWLB92RAS

3093571

Pivoting mounting bracket for WLB92 line light

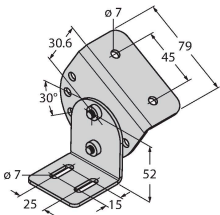

Accessories

Dimension drawing	Type	ID	
	RKC4.4T-2/TEL	6625013	Connection cable, M12 female connector, straight, 4-pin, cable length: 2 m, jacket material: PVC, black; cULus approval
	WKC4.4T-2/TEL	6625025	Connection cable, M12 female connector, angled, 4-pin, cable length: 2 m, jacket material: PVC, black; cULus approval