

# SLSP14-600P88

## Light Screen for Machine Safety Applications – Emitter/Receiver Pair

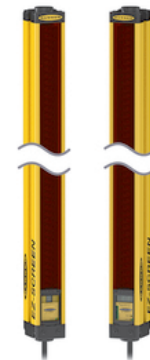
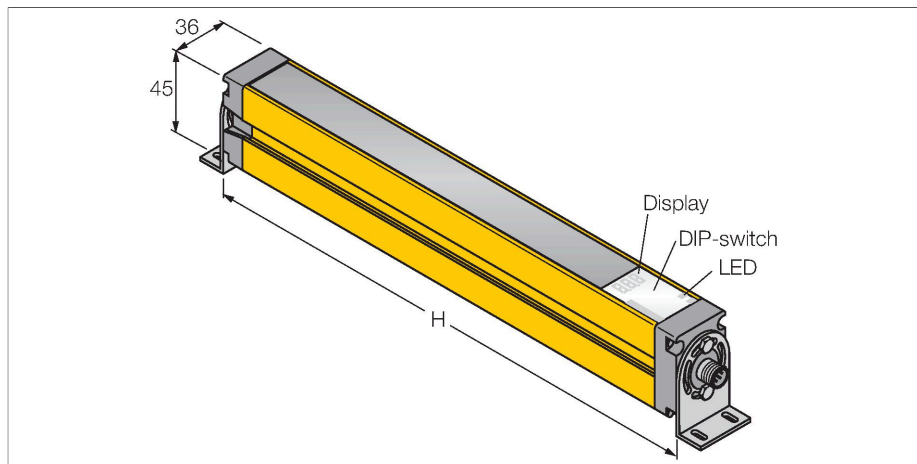

### Technical data

Type	SLSP14-600P88
ID	3073951
<b>Optical data</b>	
Function	Light screen
Light type	IR
Wavelength	950 nm
Optical resolution	14 mm
Range	100...6000 mm
Scan field	600 mm
Number of beams	80
With muting function	no
Scan Code	Adjustable
<b>Electrical data</b>	
Operating voltage	20...28 VDC
Residual ripple	< 10 % U <sub>ss</sub>
DC rated operational current	≤ 375 mA
No-load current	≤ 275 mA
Max. current safe output	500 mA
Short-circuit protection	yes
Reverse polarity protection	yes
Output function	2 x NC (normally closed), 2 x PNP
Current output	0...500 mA
Number of safe semiconductor outputs	2
Response time typical	< 23 ms
With restart interlock	yes
Blanking function	yes

### Features

- Emitter with male M12 × 1, 8-pin
- Receiver with male M12 × 1, 8-pin
- Blanking function
- Protection class IP65
- Adjustment via DIP switch
- Operating voltage 24 VDC ±15 %
- Resolution 14 mm
- Scan field 600 mm
- All devices incl. 2 EZA-MBK-11 mounting brackets; 900 mm devices and longer additionally incl. 1 EZA-MBK-12

### Wiring diagram

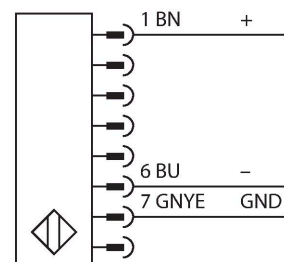
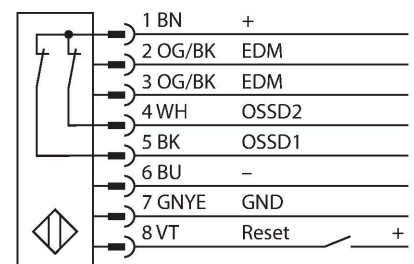

## Technical data

Mechanical data	
Design	Rectangular, EZ-Screen
Dimensions	45 x 36 x 671 mm
Housing material	Metal, AL, Yellow polyester
Lens	plastic, Acrylic
Cascadable	No
Electrical connection	Cable with connector, M12 × 1
Number of cores	8
Ambient temperature	0...+50 °C
Protection class	IP65
Power-on indication	LED, Green
Switching state	2-color LED, Red
Tests/approvals	
Vibration resistance	10-55 Hz at 0.35 mm
Shock test	10 g at 16 ms (6000 cycles)
Approvals	CE, cULus listed

## Functional principle

The high-resolution safety light screen for personnel protection consists of an emitter and a receiver. The system is optically synchronized, making the wiring between emitter and receiver redundant. The receiver's safety degree type 4 acc. to IEC 61496 is fulfilled through 2 channel monitoring of the switching device and the multiple-redundant construction with mutual processor control.

## Accessories

EZA-MBK-11

3071470

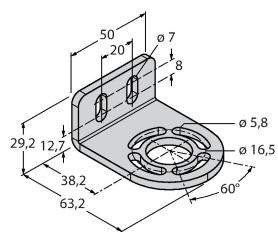

Mounting bracket, steel, black-finished, for EZ-ARRAY and EZ-SCREEN standard and cascade 14 & 30 mm

EZA-MBK-12

3071756

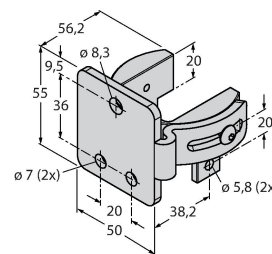

Mounting bracket, steel, black-finished, for EZ-ARRAY and EZ-SCREEN standard and cascade 14 & 30 mm

EZA-MBK-20



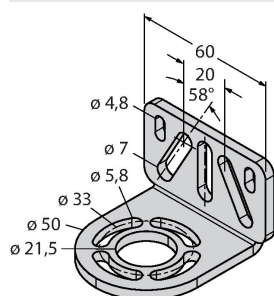

3072587



Mounting bracket, steel, black-finished, for EZ-ARRAY and EZ-SCREEN standard 14 & 30 mm

## Accessories

Dimension drawing	Type	ID	
	QDE-815D	3070883	Connection cable for safety light screens, PVC, yellow, length 4.57 m, female connection, M12 x 1, 8-pin

Dimension drawing	Type	ID	
	QDE-825D	3070884	Connection cable for safety light screens, PVC, yellow, length 7.62 m, female connection, M12 x 1, 8-pin
	QDE-850D	3070885	Connection cable for safety light screens, PVC, yellow, length 15.3 m, female connection, M12 x 1, 8-pin
	QDE-875D	3071466	Connection cable for safety light screens, PVC, yellow, length 22.9 m, female connection, M12 x 1, 8-pin
	QDE-8100D	3071467	Connection cable for safety light screens, PVC, yellow, length 30.5 m, female connection, M12 x 1, 8-pin
	DEE2R-81D	3072205	Connection cable, PVC, yellow, length: 0.31 m, female M12 x 1 - male M12, 8-pin
	DEE2R-83D	3072206	Connection cable, PVC, yellow, length: 0.91 m, female M12 x 1 - male M12, 8-pin
	DEE2R-88D_	3072635	Connection cable, PVC, yellow, length: 2.44 m, female M12 x 1 - male M12, 8-pin
	DEE2R-815D	3072207	Connection cable, PVC, yellow, length: 4.57 m, female M12 x 1 - male M12, 8-pin
	DEE2R-825D	3072208	Connection cable, PVC, yellow, length: 7.62 m, female M12 x 1 - male M12, 8-pin
	DEE2R-850D	3072209	Connection cable, PVC, yellow, length: 15.2 m, female M12 x 1 - male M12, 8-pin
	DEE2R-875D	3072210	Connection cable, PVC, yellow, length: 22.9 m, female M12 x 1 - male M12, 8-pin
	DEE2R-8100D	3072211	Connection cable, PVC, yellow, length: 30.5 m, female M12 x 1 - male M12, 8-pin
	CSB-M1280M1280	3075375	Y-piece, PVC, yellow, with male M12 x 1, 8-pin on 2 x 0.3 m cable, PVC, yellow, with female M12 x 1, 8-pin
	CSB-M1281M1281	3073252	Y-piece, PVC, yellow, length: 0.3 m with male, M12 x 1, 8-pin on 2 x 0.3 m cable, PVC, yellow, with female, M12 x 1, 8-pin
	CSB-M1288M1281	3073253	Y-piece, PVC, yellow, length: 2.5 m with male, M12 x 1, 8-pin on 2 x 0.3 m cable, PVC, yellow, with female, M12 x 1, 8-pin
	CSB-M12815M1281	3073254	Y-piece, PVC, yellow, length: 4.6 m with male, M12 x 1, 8-pin on 2 x 0.3 m cable, PVC, yellow, with female, M12 x 1, 8-pin
	CSB-M12825M1281	3073255	Y-piece, PVC, yellow, length: 7.6 m with male, M12 x 1, 8-pin on 2 x 0.3 m cable, PVC, yellow, with female, M12 x 1, 8-pin

Dimension drawing	Type	ID	
	DEE2R-88D	3094306	Connection cable, PVC, yellow, length: 2.44 m, M12 × 1 female connector, 8-pin, on M12 × 1 male connector, 8-pin